



九齊科技股份有限公司  
Nyquest Technology Co., Ltd.

使  
用  
手  
冊

# Hardware Developing Tool (Appendix)

---

## Accessory for Writer

**Version 4.90**  
**May 23, 2025**

---

NYQUEST TECHNOLOGY CO., Ltd. reserves the right to change this document without prior notice. Information provided by NYQUEST is believed to be accurate and reliable. However, NYQUEST makes no warranty for any errors which may appear in this document. Contact NYQUEST to obtain the latest version of device specifications before placing your orders. No responsibility is assumed by NYQUEST for any infringement of patent or other rights of third parties which may result from its use. In addition, NYQUEST products are not authorized for use as critical components in life support devices/systems or aviation devices/systems, where a malfunction or failure of the product may reasonably be expected to result in significant injury to the user, without the express written approval of NYQUEST.

## 目 錄

<b>1. NX_Programmer / Smart_Writer Ver.A / MCU_Writer Ver.A 轉接板和轉換板 .....</b>	<b>3</b>
1.1 COB 轉接板.....	3
1.2 DIP8/DIP14/DIP18/DIP28 轉接板.....	4
1.3 ESOP8 轉接板.....	4
1.4 SOP8/SOP14/SOP18/SOP24/SOP28 轉接板.....	5
1.5 SSOP20/SSOP24/SSO28 轉接板.....	6
1.6 SOT23-6 轉接板.....	6
1.7 LQFP32 轉接板.....	7
1.8 LQFP48 轉接板.....	7
1.9 LQFP64 轉接板.....	7
1.10 QFN16 轉接板.....	9
1.11 NY8A056A SOP16 轉換板.....	9
1.12 NX1 轉換板 (限 NX1xPxx、NX11M2x、NX11M5x 使用).....	9
1.13 NX11M_SPI_Handler 轉換板 (限 NX1xPxx、NX11M2x、NX11M5x 使用) .....	10
<b>2. Writer 專用轉卡 .....</b>	<b>12</b>
<b>3. OTP IC 轉接板及轉卡對應表 .....</b>	<b>19</b>
3.1 NY8-OTP_Writer (Ver.B) 硬體支援對應表.....	19
3.2 MCU_Writer (Ver.A) 硬體支援對應表.....	21
3.3 NX_Programmer (Ver.A) + NX1_Converter_Board (Ver.A) 硬體支援對應表.....	24
3.4 Smart_Writer Ver.A 硬體支援對應表.....	25
<b>4. 改版記錄.....</b>	<b>30</b>

## 1. NX\_Programmer / Smart\_Writer Ver.A / MCU\_Writer Ver.A 轉接板和轉換板

NX\_Programmer / Smart\_Writer Ver.A / MCU\_Writer Ver.A 硬體以各式轉接板和轉卡來支持不同封裝形式的 OTP IC 或 SPI Flash，以下分別介紹。

### 1.1 COB 轉接板

COB 轉接板支援九齊科技提供的金手指形式的 COB 和客戶自行 Layout 的 PCB，請依照轉接板上的方向標示在插入 COB 時將 COB 朝向正確的方向。

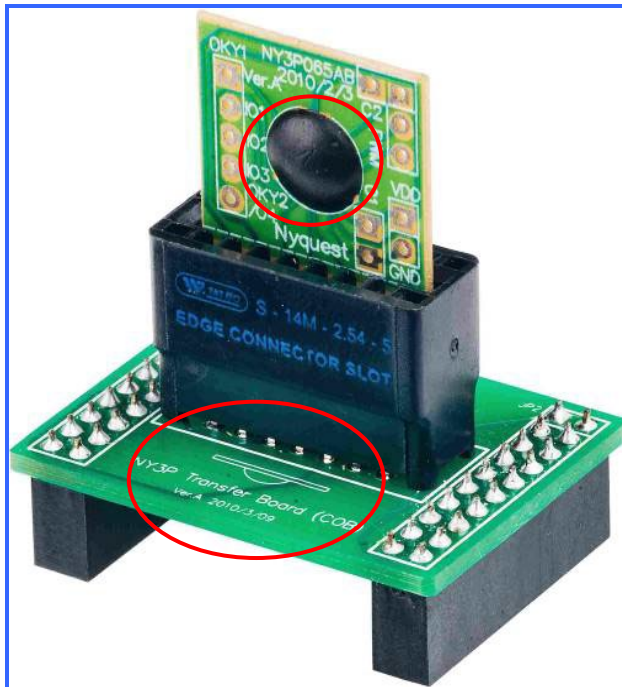

1.2 DIP8/DIP14/DIP18/DIP28 轉接板

DIP 轉接板支援九齊科技提供的 8-pin DIP、14-pin DIP、18-pin DIP 與 28-pin DIP 的 OTP IC，Textool 插座為 14-pin 或 28-pin，請依照封裝 IC 的第一腳標示（左上方），將 IC 放入 Textool 插座內並靠上對齊。

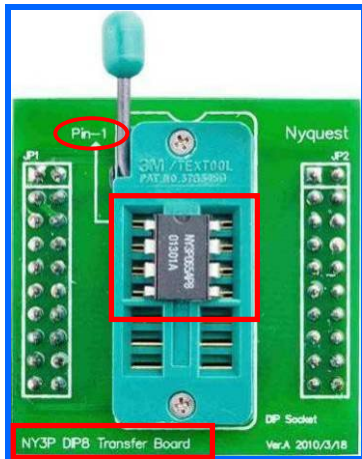

DIP8 Transfer Board

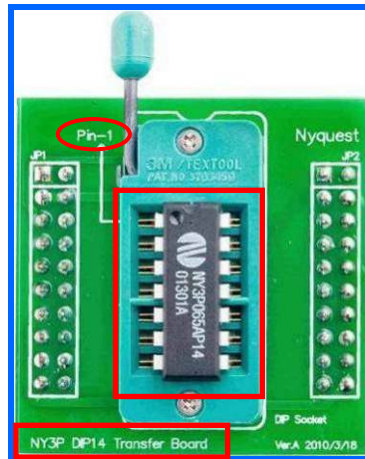

DIP14 Transfer Board

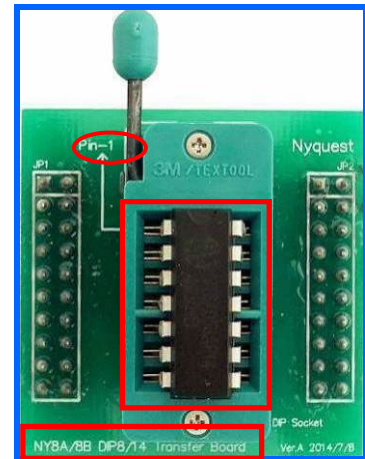

NY8A/8B DIP8/14 Transfer Board

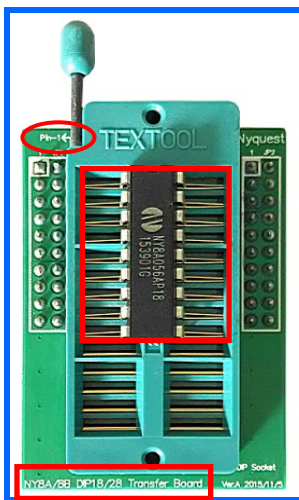

NY8A/8B DIP18/28 Transfer Board

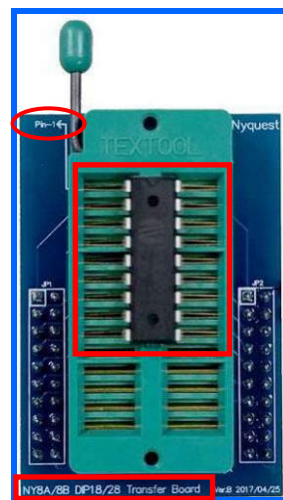

NY8A/8B DIP18/28 Transfer Board (藍色)

1.3 ESOP8 轉接板

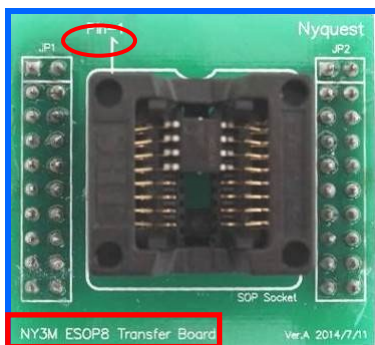

NY3M ESOP8 Transfer Board

1.4 SOP8/SOP14/SOP18/SOP24/SOP28 轉接板

SOP 轉接板支援九齊科技提供的 8-pin SOP、14-pin SOP、16-pin SOP、18-pin SOP、24-pin SOP、28-pin SOP 封裝的 OTP IC，Socket 插座為 16-pin(8-pin SOP、14-pin SOP 與 16-pin SOP)與 28-pin(18-pin SOP、24-pin SOP 與 28-pin SOP)，請依照封裝 IC 的第一腳標示(左上方)，將 IC 放入 Socket 插座內並靠上對齊。

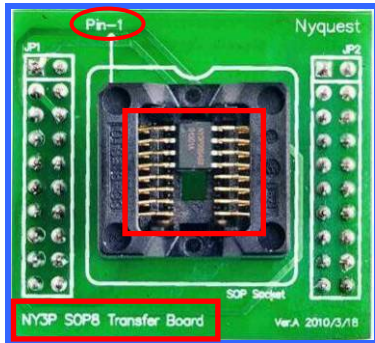

SOP8 Transfer Board

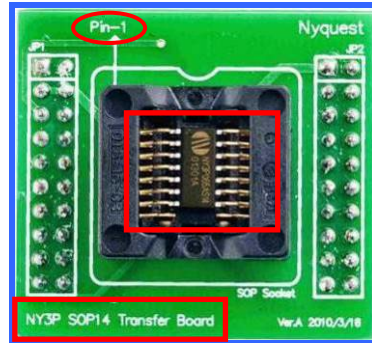

SOP14 Transfer Board

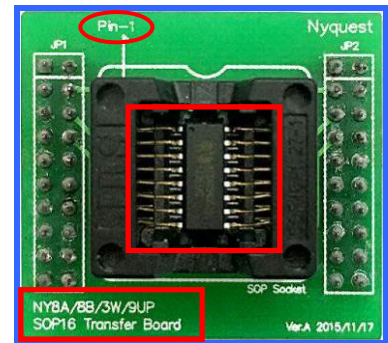

SOP16 Transfer Board

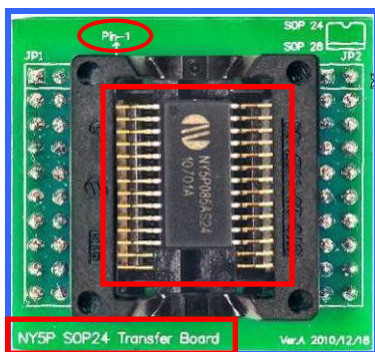

SOP24 Transfer Board

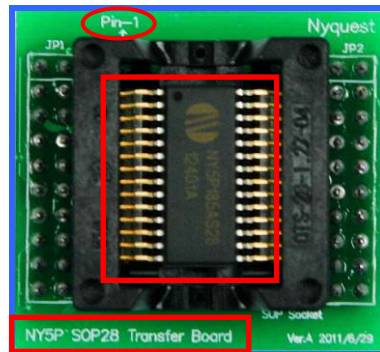

SOP28 Transfer Board

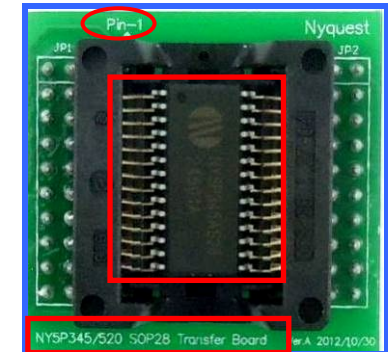

SOP28 Transfer Board for NY5P345AS28/NY5P520AS28

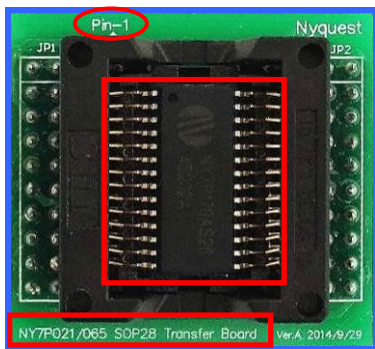

SOP28 Transfer Board for NY7P021AS28/NY7P065AS28

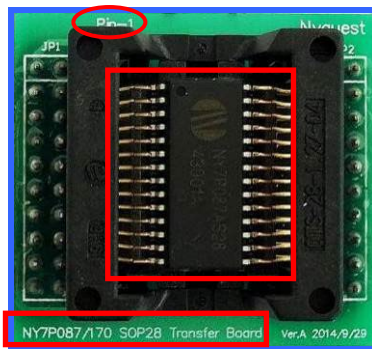

SOP28 Transfer Board for NY7P087AS28/NY7P170AS28

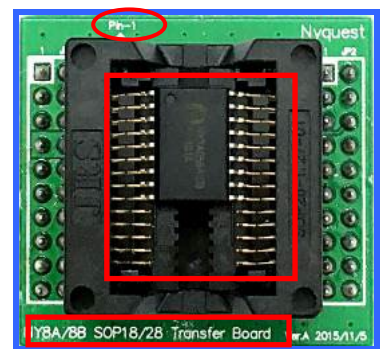

SOP18/28 Transfer Board for NY8A/8B Series

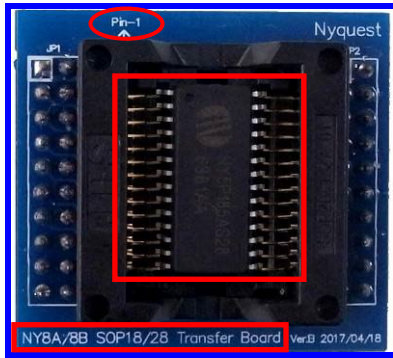

SOP18/28 Transfer Board for NY8A/8B Series (藍色)

### 1.5 SSOP20/SSOP24/SSO28 轉接板

SSOP 轉接板支援九齊科技提供的 20-pin SSOP/28-pin SSOP (209mil) 、24-pin SSOP/28-pin SSOP (150mil) 封裝的 OTP IC，Socket 插座為 28-pin (20-pin / 24-pin / 28-pin SSOP)，請依照封裝 IC 的第一腳標示 (左上方)，將 IC 放入 Socket 插座內並靠上對齊。

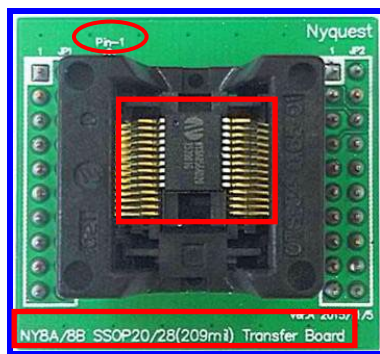

SSOP20/28 (209mil) Transfer Board for NY8A/8B Series

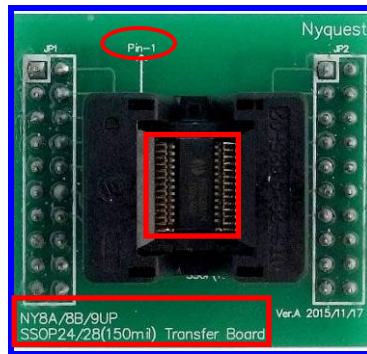

SSOP24/28 (150mil) Transfer Board for NY8A/8B/9UP Series

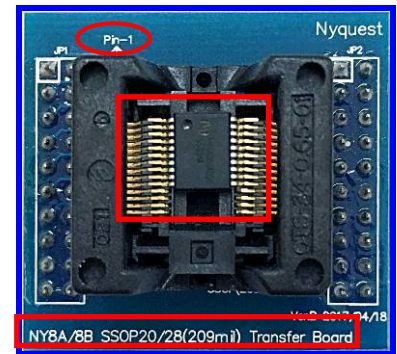

SSOP20/28 (209mil) Transfer Board for NY8A/8B Series (藍色)

### 1.6 SOT23-6 轉接板

SOT23-6 轉接板支援九齊科技提供的 SOT23-6 (63 mil) 封裝的 OTP IC，Socket 插座為 6-pin，請依照封裝 IC 的第一腳標示 (左上方)，將 IC 放入 Socket 插座內並靠上對齊。

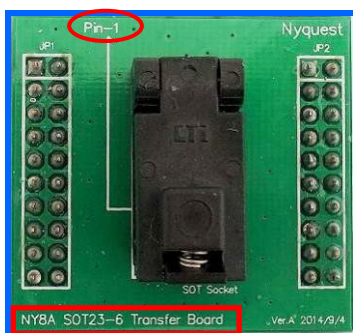

SOT23-6 Transfer Board for NY8A series

## 1.7 LQFP32 轉接板

LQFP 轉接板支援九齊科技提供的 LQFP32 封裝的 OTP IC，目前有 NX1 LQFP32 轉接板，Package OTP IC 則有：NX12P34AQ32 / NX12P44AQ32 / NX12P54AQ32 / NX12P64AQ32 / NX13P34AQ32 / NX13P44AQ32 / NX13P54AQ32 / NX13P64AQ32 / NX12FS51AQ32 / NX13FS51AQ32。

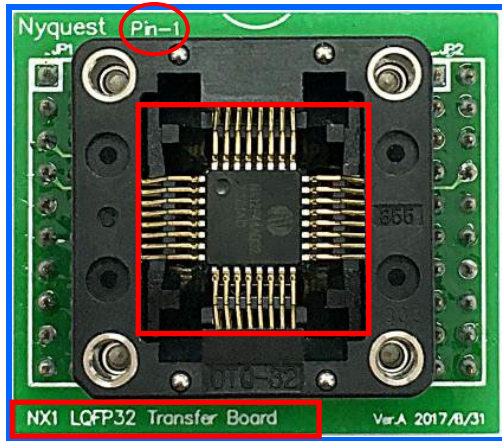

## 1.8 LQFP48 轉接板

LQFP 轉接板支援九齊科技提供的 LQFP48 封裝的 OTP IC，目前有 NX1 LQFP48 轉接板，Package OTP IC 則有：NX11P22AQ48，NY5P520JQ48，NY5P720JQ48。

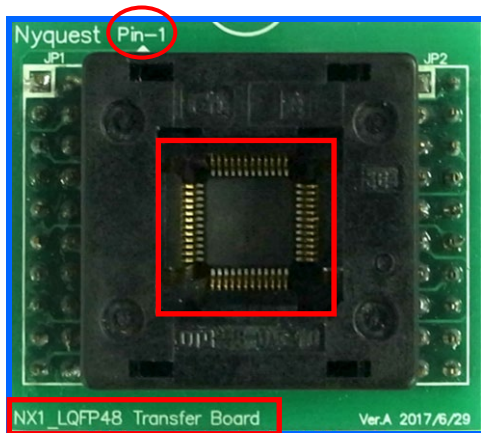

## 1.9 LQFP64 轉接板

LQFP 轉接板支援九齊科技提供的 LQFP64 封裝的 OTP IC，目前有 NY5P LQFP64、NY7P LQFP64 與 NX1 LQFP64 三種轉接板，Package OTP IC 則有：NY5P345AQ64 / NY5P520AQ64 / NY5P720AQ64 / NY7P087AQ64 / NY7P170AQ64 / NY7P345AQ64 / NY7P520AQ64 / NX12P34AQ64 / NX12P44AQ64 / NX12P54AQ64 / NX12P64AQ64 / NX13P34AQ64 / NX13P44AQ64 / NX13P54AQ64 / NX13P64AQ64。

Textool 插座為 64-pin，請依照封裝 IC 的第一腳標示（左上方），將 IC 放入 Textool 插座內。

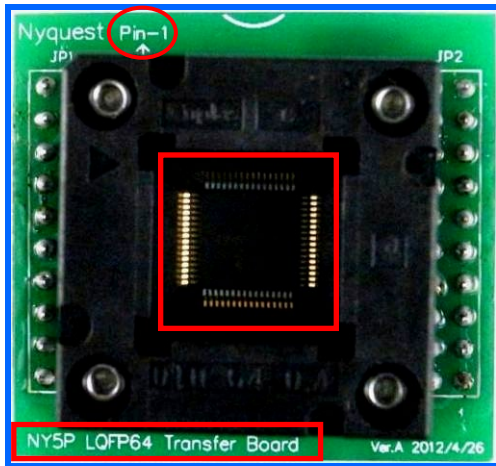

當使用 NY5P LQFP64 轉接板燒錄時，需要將轉接板背面的撥碼開關撥到與 OTP IC 型號相應的位置。

LQFP64 轉接板燒錄 NY5P345AQ64 的 OTP IC 時，請將右下角的 NY5P345A 全部撥碼開關（8 個）撥到 On 的位置，同時，也需要將左上角的撥碼開關撥到 Off 的位置，如下圖所示：

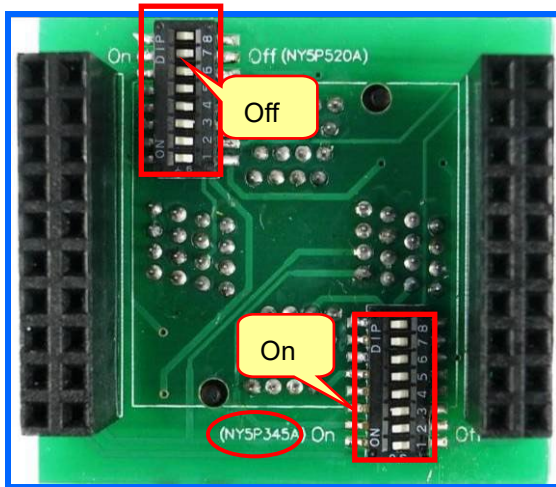

LQFP64 轉接板燒錄 NY5P520AQ64 的 OTP IC 時，請將左上角的 NY5P520A 全部撥碼開關（8 個）撥到 On 的位置，同時，也需要將右下角的撥碼開關撥到 Off 的位置，如下圖所示：

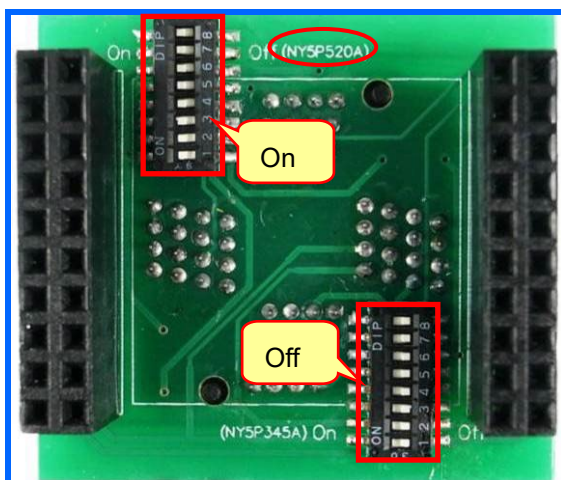

**1.10 QFN16 轉接板**

QFN16 轉接板支援九齊科技提供的 QFN16 封裝的 IC，Socket 插座為 16-pin，請依照封裝 IC 的第一腳標示（左方），將 IC 放入 Socket 插座內並對齊。

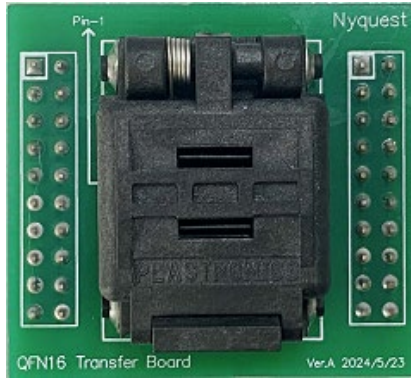

QFN16 Transfer Board

**1.11 NY8A056A SOP16 轉換板**

NY8A056A SOP16 Converter\_Board 燒錄 NY8A056A SOP16 的 OTP IC 時，將 16-pin SOP 轉接板置於 NY8A056A SOP16 Converter\_Board 上方，再搭配 NY8A053 DIP/SOP 轉卡，方可燒錄。

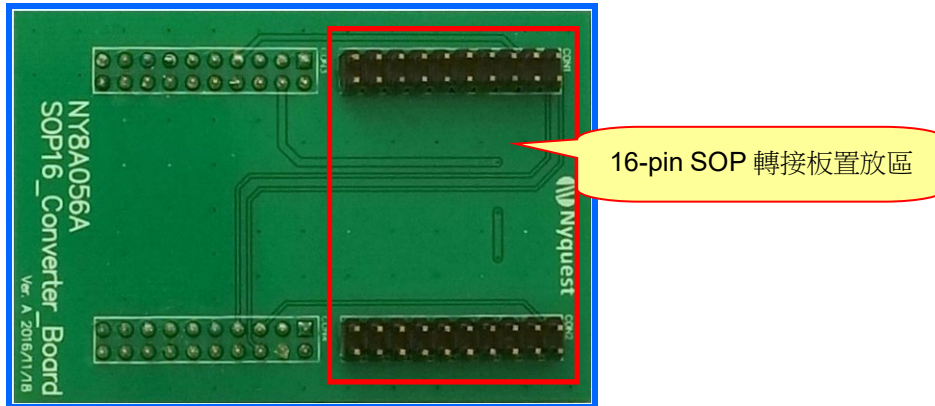

**1.12 NX1 轉換板 (限 NX1xPxx、NX11M2x、NX11M5x 使用)**

使用 NX\_Programmer Ver.A 燒錄 SOP8/SOP16/SSOP24/LQFP32/LQFP48/LQFP64 和 COB 包裝的 NX1 時，必須選擇相對應包裝的 OTP\_Writer 轉卡與轉接板插座置入 NX1 轉換板上，NX\_Programmer Ver.A 即可燒錄 NX1。

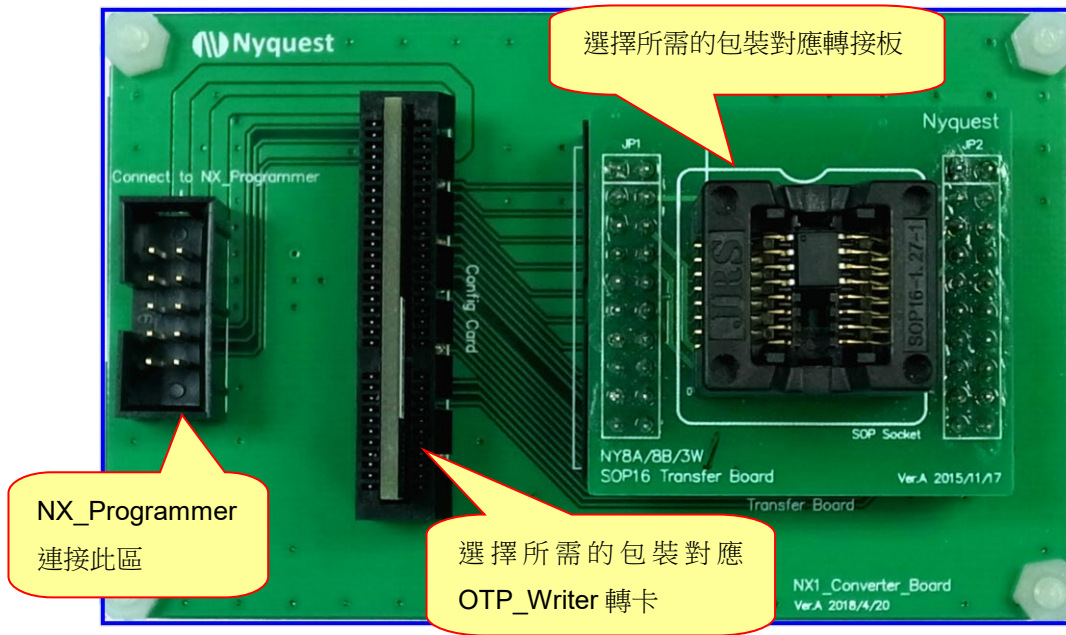

### 1.13 NX11M\_SPI\_Handler 轉換板 (限 NX1xPxx、NX11M2x、NX11M5x 使用)

使用 NX\_Programmer Ver.A 在自燒錄機台燒錄 SOP8/SOP16 NX11M 時，必須要透過此轉板進行燒錄，而 NX\_Programmer Ver.A 上透過 ECI 介面插槽，固定並且直立於轉接板上，如下圖組裝所示：



在自燒錄臺上有兩個介面需與此轉接板連接，此兩個介面分別是燒錄探針介面與機台控制介面。自燒錄臺上的燒錄探針介面透過燒錄傳輸線引出，根據所要燒錄 IC 的型號與包裝類型在轉接板上選擇對應規格腳座，採用點對點的方式連接燒錄。自燒錄臺上的機台控制介面有 VDD / GND / Start / Pass / Fail / Busy 等信號，

採用點對點的方式連接至轉接板上的 VDD / GND / Start / Pass / Fail / Busy 等信號，另外此轉接板提供 Pass/Busy/Fail LED 指示燈，讓使用者透過三個指示燈能夠更直覺辨識目前燒錄狀況，如下圖所示：

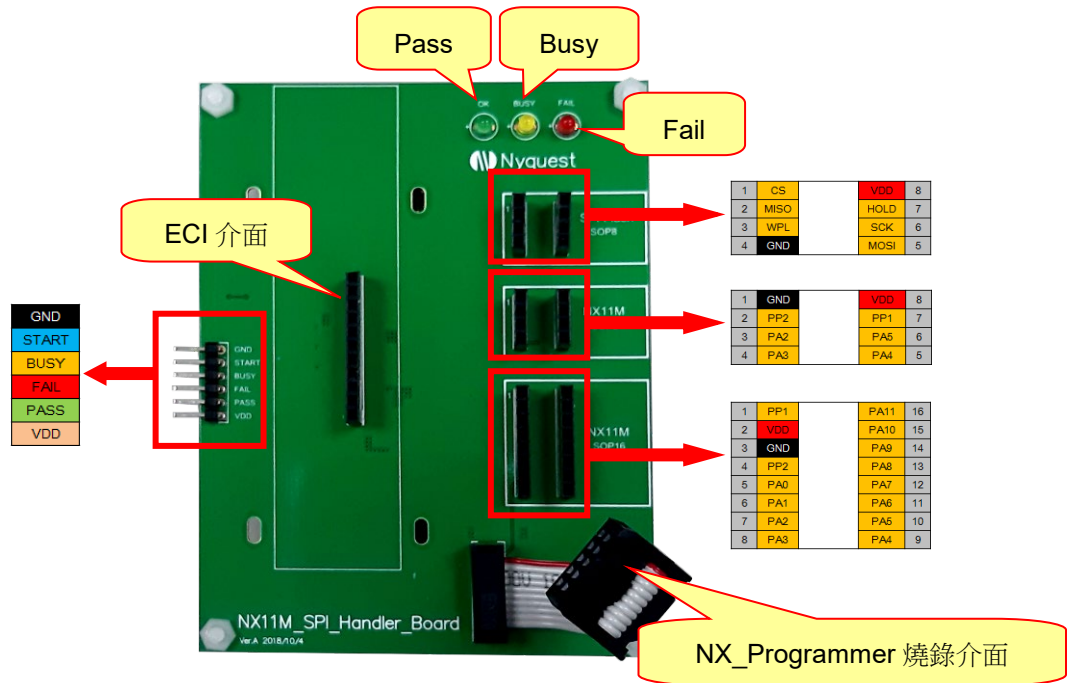

## 2. Writer 專用轉卡

Writer 硬體以各式轉卡來支援不同系列的 OTP IC。以下為現有的各系列的轉卡：

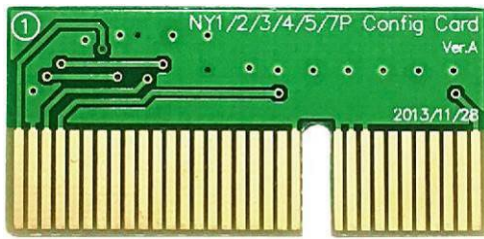

NY1/2/3/4/5/7P 轉卡 (Config Card)



NY8A053 DIP/SOP 轉卡 (Config Card)



NY8A051 DIP/SOP/SOT 轉卡 (Config Card)

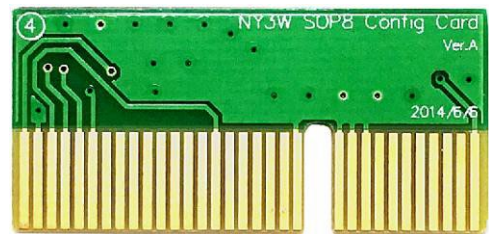

NY3W SOP 轉卡 (Config Card)

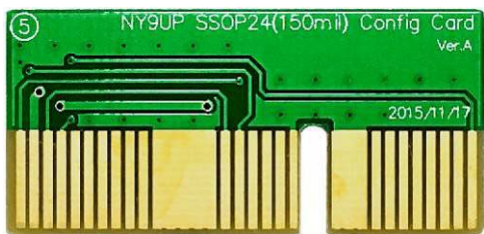

NY9UP SSOP24 轉卡 (Config Card)

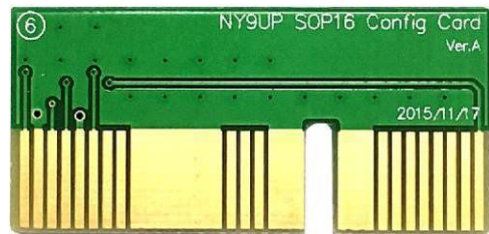

NY9UP SOP16 轉卡 (Config Card)

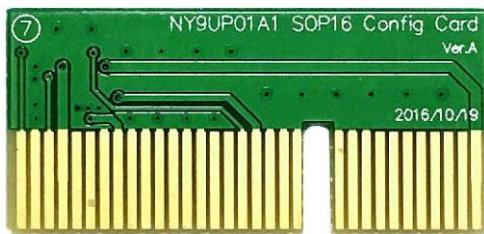

NY9UP01A1 SOP16 轉卡 (Config Card)

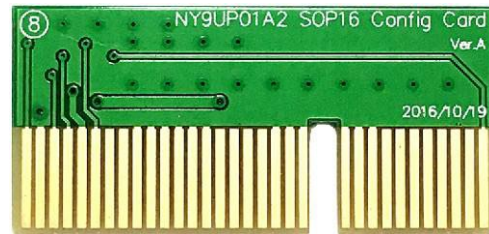

NY9UP01A2 SOP16 轉卡 (Config Card)

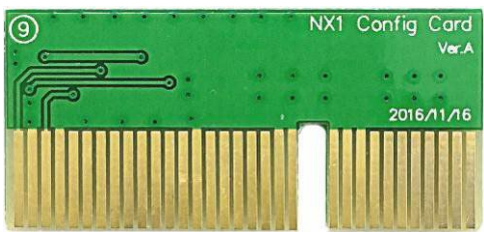

NX1 轉卡 (Config Card)



NY8B071 DIP/SOP14 轉卡 (Config Card)

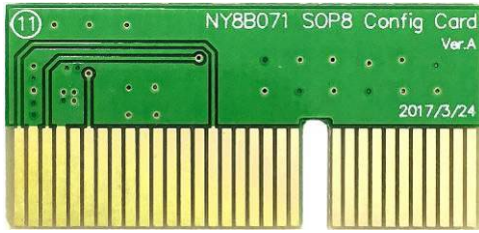

NY8B071 SOP8 轉卡 (Config Card)



NY8A056 DIP/SOP18/SSOP20 轉卡 (Config Card)

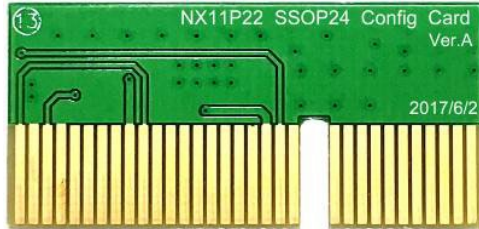

NX11P22 SSOP24 轉卡 (Config Card)

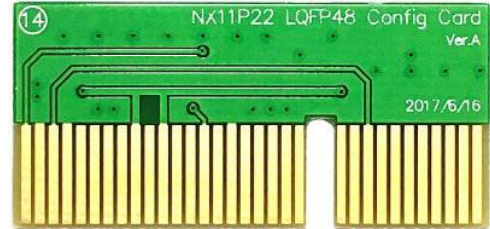

NX11P22 LQFP48 轉卡 (Config Card)



NY8A054 DIP/SOP 轉卡 (Config Card)

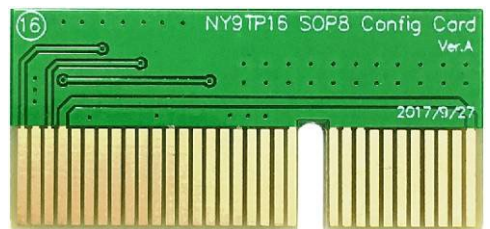

NY9TP16 SOP8 轉卡 (Config Card)



NY9TP16 SOP16/SOP28/SSOP24 轉卡 (Config Card)

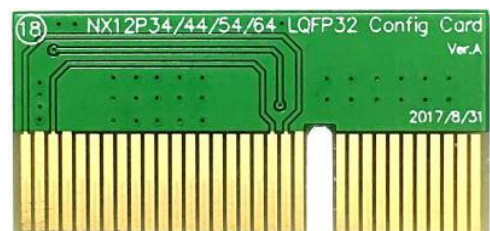

NX12P34/44/54/64 LQFP32 轉卡 (Config Card)

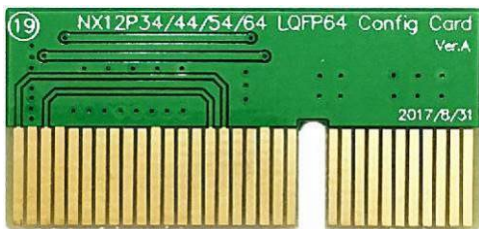

NX12P34/44/54/64 LQFP64 轉卡 (Config Card)

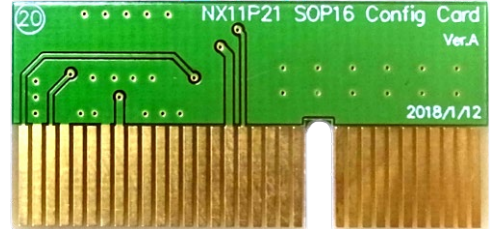

NX11P21 SOP16 轉卡 (Config Card)



NX11P21 SSOP24 轉卡 (Config Card)

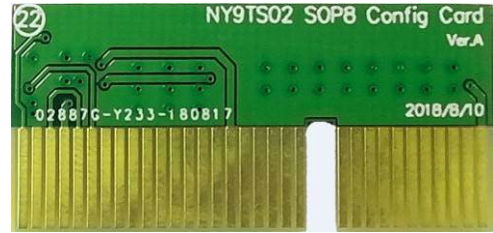

NY9TS02 SOP8 轉卡 (Config Card)

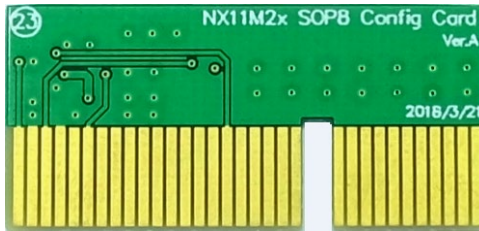

NX11M2x SOP8 轉卡 (Config Card)

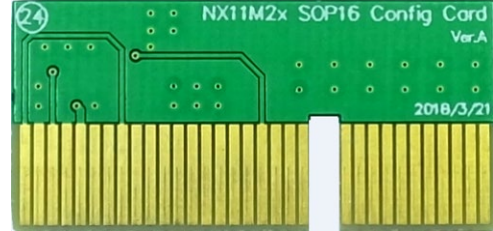

NX11M2x SOP16 轉卡 (Config Card)

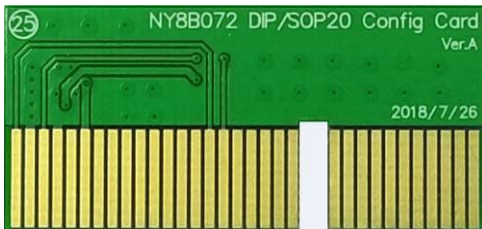

NY8B072 DIP/SOP20 轉卡 (Config Card)



NX12P34/54/64 SSOP24 轉卡 (Config Card)



NX12P34/54/64 LQFP48 轉卡 (Config Card)



NY6P085J SOP24 轉卡 (Config Card)

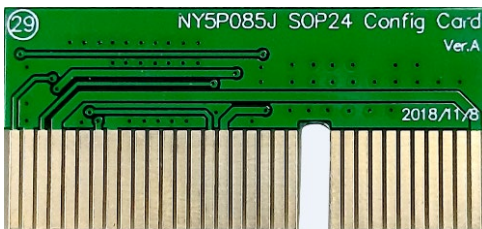

NY5P085J SOP24 轉卡 (Config Card)



NY9UP08A SOP16 轉卡 (Config Card)

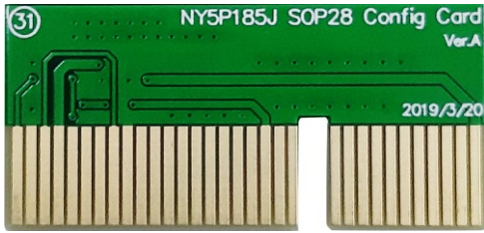

NY5P185J SOP28 轉卡 (Config Card)

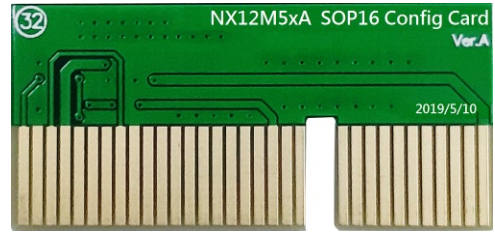

NX12M5xA SOP16 轉卡 (Config Card)

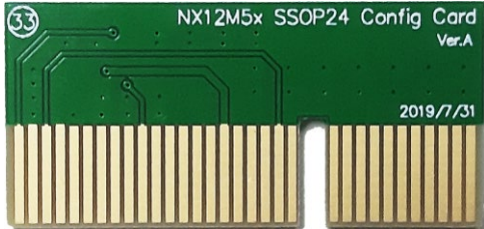

NX12M5x SSOP24 轉卡 (Config Card)

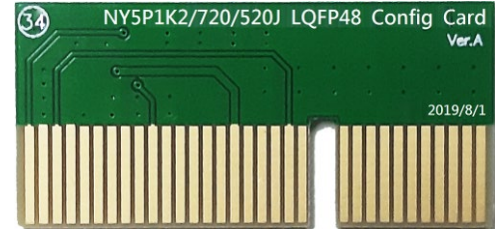

NY5P1K2/720/520J LQFP48 轉卡 (Config Card)

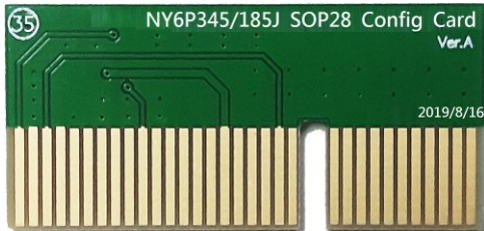

NY6P345/185J SOP28 轉卡 (Config Card)



NY8BM72 SOP20 轉卡 (Config Card)



NY8BM72 SOP16 轉卡 (Config Card)



NY6P025A SOP14 轉卡 (Config Card)

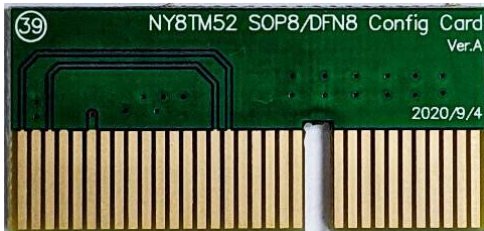

NY8TM52 SOP8/DFN8/COB 轉卡 (Config Card)



NY8BE62 SOP8 轉卡 (Config Card)

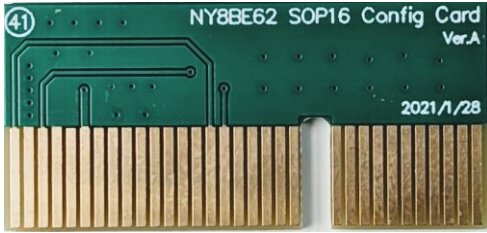

NY8BE62 SOP16 轉卡 (Config Card)



NY8TE64 SOP20 轉卡 (Config Card)



NY5Q060/092/172 SSOP24 轉卡 (Config Card)  
NY5Q020/040 SOP14

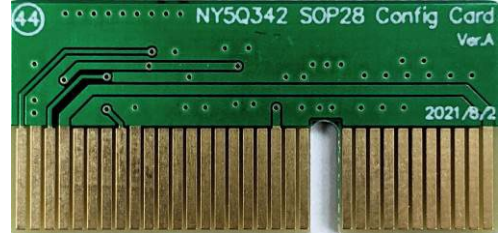

NY5Q342 SOP28 轉卡 (Config Card)

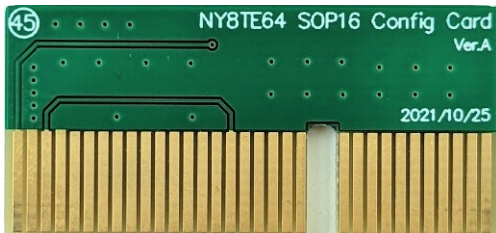

NY8TE64 SOP16 轉卡 (Config Card)



NX12FM5x/NX12FS51 SOP16 轉卡  
(Config Card)

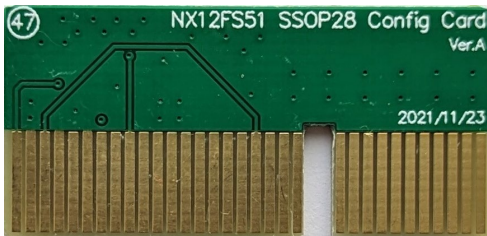

NX12FS51 SSOP28 轉卡 (Config Card)



NX12FS51 LQFP32 轉卡 (Config Card)

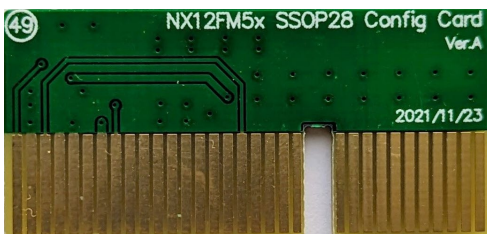

NX12FM5x SSOP28 轉卡 (Config Card)

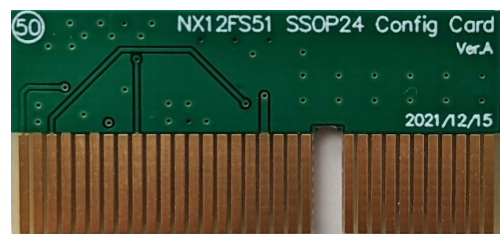

NX12FS51 SSOP24 轉卡 (Config Card)

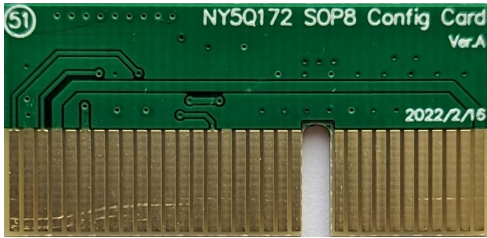

NY5Q172 SOP8 轉卡 (Config Card)

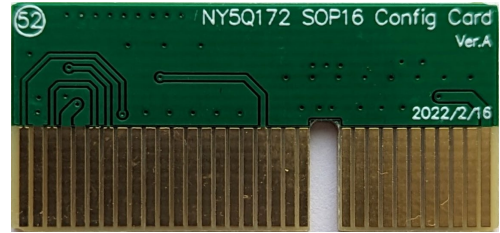

NY5Q172 SOP16 轉卡 (Config Card)

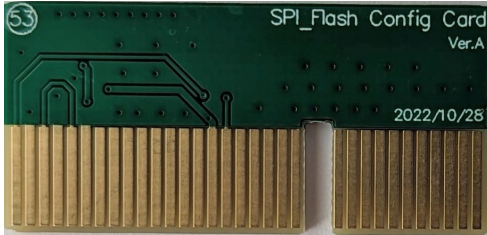

SPI\_Flash SOP8 轉卡 (Config Card)



NX11FS2x SOP8 轉卡 (Config Card)



NX11FS2x SOP16 轉卡 (Config Card)



NX11FS2x SSOP24 轉卡 (Config Card)

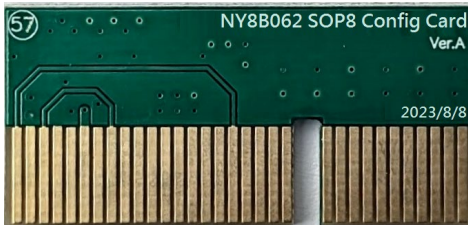

NY8B062 SOP8 轉卡 (Config Card)



NY8B062 SOP14 轉卡 (Config Card)



NY3P016/035 SOT23-6 轉卡 (Config Card)

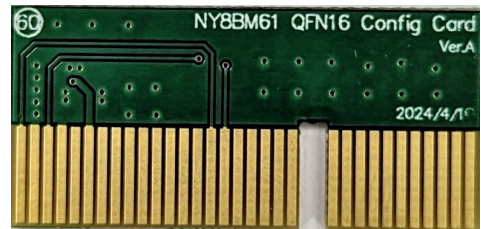

NY8BM61 QFN16 轉卡 (Config Card)



NY8BM62 SOP8 轉卡 (Config Card)



NY3PxxxE SOP8 轉卡 (Config Card)



NY8BM84/8F2481 TSSOP20 轉卡 (Config Card)



NY8BM84/8F2481 SSOP24/QFN24 轉卡



NY8BM84/8F2481 SOP16 轉卡 (Config Card)

### 3. OTP IC 轉接板及轉卡對應表

#### 3.1 NY8-OTP\_Writer (Ver.B) 硬體支援對應表

下表為 OTP IC 對應的轉接板及轉卡來支援不同系列的 Nyquest IC。

Series	P/N	Type	轉卡 (Config Card)	轉接板 (Transfer Board)	通用轉接板 (Uni-Transfer Board)
NY8A050x	NY8A050xS6	SOT23-6	3. NY8A051 DIP/SOP/SOT Config Card	NY8A SOT23-6 Transfer Board Ver.A	SOP16 Transfer Board Ver.A
	NY8A050xS8	SOP8		NY8A / NY8B / NY3W / NY9UP SOP16 Transfer Board Ver.A	
NY8A051x	NY8A051xS6	SOT23-6	3. NY8A051 DIP/SOP/SOT Config Card	NY8A SOT23-6 Transfer Board Ver.A	SOP16 Transfer Board Ver.A
	NY8A051xS8	SOP8		NY8A / NY8B / NY3W / NY9UP SOP16 Transfer Board Ver.A	
	NY8A051xP8	DIP8		NY8A/8B DIP8/14 Transfer Board Ver.A	
NY8AE51x	NY8AE51xS6	SOT23-6	3. NY8A051 DIP/SOP/SOT Config Card	NY8A SOT23-6 Transfer Board Ver.A	SOP16 Transfer Board Ver.A
	NY8AE51xS8	SOP8	3. NY8A051 DIP/SOP/SOT Config Card	NY8A / NY8B / NY3W / NY9UP SOP16 Transfer Board Ver.A	
	NY8AE51xP8	SOP8	3. NY8A051 DIP/SOP/SOT Config Card	NY8A / NY8B / NY3W / NY9UP DIP18/28 Transfer Board Ver.A	
NY8A053x	NY8A053xS8	SOP8	3. NY8A051 DIP/SOP/SOT Config Card	NY8A / NY8B / NY3W / NY9UP SOP16 Transfer Board Ver.A	SOP16 Transfer Board Ver.A
	NY8A053xS14	SOP14	2. NY8A053 DIP/SOP Config Card		
	NY8A053xP14	DIP14		NY8A/8B DIP8/14 Transfer Board Ver.A	DIP8/14 Transfer Board Ver.A
NY8A054x	NY8A054xS8	SOP8	3. NY8A051 DIP/SOP/SOT Config Card	NY8A / NY8B / NY3W / NY9UP SOP16 Transfer Board Ver.A	SOP16 Transfer Board Ver.A
	NY8A054xS16	SOP16	15. NY8A054 DIP/SOP Config Card		
NY8A056x	NY8A056xS16	SOP16	2. NY8A053 DIP/SOP Config Card	NY8A/8B/3W/9UP SOP16 Transfer Board + NY8A056A SOP16_Converter_Board Ver.A	SOP16 Transfer Board Ver.A + NY8A056A SOP16_Converter_Board Ver.A
	NY8A056xS18	SOP18	12. NY8A056 DIP/SOP18/SSOP20	NY8A/8B SOP18 / 28 Transfer Board Ver.B	SOP18 / 28 Transfer Board Ver.A
	NY8A056xP18	DIP18		NY8A/8B DIP18 / 28 Transfer Board Ver.B	DIP18 / 28 Transfer Board Ver.A
	NY8A056xD20	SSOP20		NY8A/8B SSOP20/28 (209mil) Transfer Board Ver.B	SSOP20/28 (209mil) Transfer Board Ver.A
NY8B060x	NY8B060xS8	SOP8	11. NY8B071 SOP8 Config Card	NY8A/8B/3W/9UP SOP16 Transfer Board Ver.A	SOP16 Transfer Board Ver.A

Series	P/N	Type	轉卡 (Config Card)	轉接板 (Transfer Board)	通用轉接板 (Uni-Transfer Board)
<b>NY8B061x</b>	NY8B061xS8	SOP8	11. NY8B071 SOP8 Config Card	NY8A/8B/3W/9UP SOP16 Transfer Board Ver.A	SOP16 Transfer Board Ver.A
	NY8B061xS14	SOP14	10. NY8B071 DIP/SOP14 Config Card		
	NY8B061xS16	SOP16			
<b>NY8B062x</b>	NY8B062xS8	SOP8	11. NY8B071 SOP8 Config Card 57. NY8B062 SOP8 Config Card	NY8A/8B/3W/9UP SOP16 Transfer Board Ver.A	SOP16 Transfer Board Ver.A
	NY8B062xS14	SOP14	10. NY8B071 DIP/SOP14 Config Card 58. NY8B062 SOP14 Config Card		
	NY8B062xS16	SOP16			
<b>NY8B071x</b>	NY8B071xS8	SOP8	11. NY8B071 SOP8 Config Card	NY8A / NY8B / NY3W / NY9UP SOP16 Transfer Board Ver.A	SOP16 Transfer Board Ver.A
	NY8B071xS14	SOP14	10. NY8B071 DIP/SOP14 Config Card		
<b>NY8B072x</b>	NY8B072xS20	SOP20	25. NY8B072 DIP/SOP20 Config Card	NY8A/8B SOP18/28 Transfer Board Ver.B	SOP18/28 Transfer Board Ver.A
	NY8B072xP20	DIP20		NY8A/8B DIP18 / 28 Transfer Board Ver.B	DIP18 / 28 Transfer Board Ver.A
<b>NY8BE62x</b>	NY8BE62xS8	SOP8	40. NY8BE62 SOP8 Config Card	NY8A/8B/3W/9UP SOP16 Transfer Board Ver.A	SOP16 Transfer Board Ver.A
	NY8BE62xS14	SOP14	41. NY8BE62 SOP16 Config Card 58. NY8B062 SOP14 Config Card	NY8A/8B/3W/9UP SOP16 Transfer Board Ver.A	SOP16 Transfer Board Ver.A
	NY8BE62xS16	SOP16	41. NY8BE62 SOP16 Config Card 58. NY8B062 SOP14 Config Card	NY8A/8B/3W/9UP SOP16 Transfer Board Ver.A	SOP16 Transfer Board Ver.A
<b>NY8BE64x</b>	NY8TE64xS16	SOP16	45. NY8TE64 SOP16 Config Card	NY8A/8B/3W/9UP SOP16 Transfer Board Ver.A	SOP16 Transfer Board Ver.A
	NY8TE64xS20	SOP20	42. NY8TE64 SOP20 Config Card	NY8A/8B SOP18/28 Transfer Board Ver.B	SOP18/28 Transfer Board Ver.A
<b>NY8BM61x</b>	NY8BM61xS8	SOP8	61. NY8BM62 SOP8 Config Card	NY8A/8B/3W/9UP SOP16 Transfer Board Ver.A	SOP16 Transfer Board Ver.A
	NY8BM61xS14	SOP14	58. NY8B062 SOP14 Config Card	NY8A/8B/3W/9UP SOP16 Transfer Board Ver.A	SOP16 Transfer Board Ver.A
	NY8BM61xS16	SOP16	58. NY8B062 SOP14 Config Card	NY8A/8B/3W/9UP SOP16 Transfer Board Ver.A	SOP16 Transfer Board Ver.A
	NY8BM61xNA16	QFN16	58. NY8B062 SOP14 Config Card 60. NY8BM61 QFN16 Config Card		QFN16 Transfer Board Ver.A
<b>NY8BM62x</b>	NY8BM62xS8	SOP8	61. NY8BM62 SOP8 Config Card	NY8A/8B/3W/9UP SOP16 Transfer Board Ver.A	SOP16 Transfer Board Ver.A
	NY8BM62xS14	SOP14	58. NY8B062 SOP14 Config Card	NY8A/8B/3W/9UP SOP16 Transfer Board Ver.A	SOP16 Transfer Board Ver.A

Series	P/N	Type	轉卡 (Config Card)	轉接板 (Transfer Board)	通用轉接板 (Uni-Transfer Board)
	NY8BM62xS16	SOP16	58. NY8B062 SOP14 Config Card	NY8A/8B/3W/9UP SOP16 Transfer Board Ver.A	SOP16 Transfer Board Ver.A
	NY8BM62xNA16	QFN16	58. NY8B062 SOP14 Config Card 60. NY8BM61 QFN16 Config Card		QFN16 Transfer Board Ver.A
NY8BM72x	NY8BM72xS20	SOP20	36. NY8BM72 SOP20 Config Card	NY8A/8B SOP18/28 Transfer Board Ver.B	SOP18/28 Transfer Board Ver.A
	NY8BM72xP20	DIP20	36. NY8BM72 SOP20 Config Card	NY8A/8B DIP18 / 28 Transfer Board Ver.B	DIP18 / 28 Transfer Board Ver.A
	NY8BM72xS16	SOP16	37. NY8BM72 SOP16 Config Card	NY8A/8B/3W/9UP SOP16 Transfer Board Ver.A	SOP16 Transfer Board Ver.A
NY8BM84A	NY8BM84AS16	SOP16	67. NY8BM84/8F2481 SOP16 Config Card	NY8A/8B/3W/9UP SOP16 Transfer Board Ver.A	SOP16 Transfer Board Ver.A
	NY8BM84AT20	TSSOP20	63. NY8BM84/8F2481 TSSOP20 Config Card	--	--
	NY8BM84AU24	SSOP24	64. NY8BM84/8F2481 SSOP24/QFN24 Config card	NY8A/8B/9UP SSOP24/28(150mil) Transfer Board Ver.A	SSOP24/28(150mil) Transfer Board Ver.A
	NY8BM84ANA24	QFN24	64. NY8BM84/8F2481 SSOP24/QFN24 Config card	--	--
NY8TE64x	NY8TE64xS16	SOP16	45. NY8TE64 SOP16 Config Card	NY8A/8B/3W/9UP SOP16 Transfer Board Ver.A	SOP16 Transfer Board Ver.A
	NY8TE64xS20	SOP20	42. NY8TE64 SOP20 Config Card	NY8A/8B SOP18/28 Transfer Board Ver.B	SOP18/28 Transfer Board Ver.A
NY8TM52x	NY8TM52xS8	SOP8	39. NY8TM52 SOP8/DFN8/COB Config Card	NY8A/8B/3W/9UP SOP16 Transfer Board Ver.A	SOP16 Transfer Board Ver.A
	NY8TM52xS6	SOT23-6	3. NY8A051 DIP/SOP/SOT Config Card	NY8A SOT23-6 Transfer Board Ver.A	
NY9UP02x	NY9UP02xS16	SOP16	8. NY9UP01A2 SOP16 Config Card	NY8A/8B/3W/9UP SOP16 Transfer Board Ver.A	SOP16 Transfer Board Ver.A

### 3.2 MCU\_Writer (Ver.A) 硬體支援對應表

下表為 OTP IC 對應的轉卡來支援不同系列的 Nyquest IC。轉接板請使用市面上 pin to pin 的對應封裝轉接板。

Series	P/N	Type	轉卡 (Config Card)
NY8A050x	NY8A050xS6	SOT23-6	3. NY8A051 DIP/SOP/SOT Config Card
	NY8A050xS8	SOP8	
NY8A051x	NY8A051xS6	SOT23-6	3. NY8A051 DIP/SOP/SOT Config Card
	NY8A051xS8	SOP8	
	NY8A051xP8	DIP8	

Series	P/N	Type	轉卡 (Config Card)
NY8AE51x	NY8AE51xS6	SOT23-6	3. NY8A051 DIP/SOP/SOT Config Card
	NY8AE51xS8	SOP8	3. NY8A051 DIP/SOP/SOT Config Card
	NY8AE51xP8	SOP8	3. NY8A051 DIP/SOP/SOT Config Card
NY8A053x	NY8A053xS8	SOP8	3. NY8A051 DIP/SOP/SOT Config Card
	NY8A053xS14	SOP14	2. NY8A053 DIP/SOP Config Card
	NY8A053xP14	DIP14	
NY8A054x	NY8A054xS8	SOP8	3. NY8A051 DIP/SOP/SOT Config Card
	NY8A054xS16	SOP16	15. NY8A054 DIP/SOP Config Card
NY8A056x	NY8A056xS16	SOP16	2. NY8A053 DIP/SOP Config Card
	NY8A056xS18	SOP18	12. NY8A056 DIP/SOP18/SSOP20
	NY8A056xP18	DIP18	
	NY8A056xD20	SSOP20	
NY8B060x	NY8B060xS8	SOP8	11. NY8B071 SOP8 Config Card
NY8B061x	NY8B061xS8	SOP8	11. NY8B071 SOP8 Config Card
	NY8B061xS14	SOP14	10. NY8B071 DIP/SOP14 Config Card
	NY8B061xS16	SOP16	
NY8B062x	NY8B062xS8	SOP8	11. NY8B071 SOP8 Config Card 57. NY8B062 SOP8 Config Card
	NY8B062xS14	SOP14	10. NY8B071 DIP/SOP14 Config Card 58. NY8B062 SOP14 Config Card
	NY8B062xS16	SOP16	
NY8B071x	NY8B071xS8	SOP8	11. NY8B071 SOP8 Config Card

Series	P/N	Type	轉卡 (Config Card)
	NY8B071xS14	SOP14	10. NY8B071 DIP/SOP14 Config Card
NY8B072x	NY8B072xS20	SOP20	25. NY8B072 DIP/SOP20 Config Card
	NY8B072xP20	DIP20	
NY8BE62x	NY8BE62xS8	SOP8	40. NY8BE62 SOP8 Config Card
	NY8BE62xS14	SOP14	41. NY8BE62 SOP16 Config Card 58. NY8B062 SOP14 Config Card
	NY8BE62xS16	SOP16	41. NY8BE62 SOP16 Config Card 58. NY8B062 SOP14 Config Card
NY8BE64x	NY8TE64xS16	SOP16	45. NY8TE64 SOP16 Config Card
	NY8TE64xS20	SOP20	42. NY8TE64 SOP20 Config Card
NY8BM61x	NY8BM61xS8	SOP8	61. NY8BM62 SOP8 Config Card
	NY8BM61xS14	SOP14	58. NY8B062 SOP14 Config Card
	NY8BM61xS16	SOP16	58. NY8B062 SOP14 Config Card
	NY8BM61xNA16	QFN16	58. NY8B062 SOP14 Config Card 60. NY8BM61 QFN16 Config Card
NY8BM62x	NY8BM62xS8	SOP8	61. NY8BM62 SOP8 Config Card
	NY8BM62xS14	SOP14	58. NY8B062 SOP14 Config Card
	NY8BM62xS16	SOP16	58. NY8B062 SOP14 Config Card
	NY8BM62xNA16	QFN16	58. NY8B062 SOP14 Config Card 60. NY8BM61 QFN16 Config Card
NY8BM72x	NY8BM72xS20	SOP20	36. NY8BM72 SOP20 Config Card
	NY8BM72xP20	DIP20	36. NY8BM72 SOP20 Config Card
	NY8BM72xS16	SOP16	37. NY8BM72 SOP16 Config Card
NY8BM84A	NY8BM84AS16	SOP16	67. NY8BM84/8F2481 SOP16 Config Card
	NY8BM84AT20	TSSOP20	63. NY8BM84/8F2481 TSSOP20 Config Card
	NY8BM84AU24	SSOP24	64. NY8BM84/8F2481 SSOP24/QFN24 Config card
	NY8BM84ANA24	QFN24	64. NY8BM84/8F2481 SSOP24/QFN24 Config card

Series	P/N	Type	轉卡 (Config Card)
NY8TE64x	NY8TE64xS16	SOP16	45. NY8TE64 SOP16 Config Card
	NY8TE64xS20	SOP20	42. NY8TE64 SOP20 Config Card
NY8TM52x	NY8TM52xS8	SOP8	39. NY8TM52 SOP8/DFN8/COB Config Card
	NY8TM52xS6	SOT23-6	3. NY8A051 DIP/SOP/SOT Config Card
NY9UP02x	NY9UP02xS16	SOP16	8. NY9UP01A2 SOP16 Config Card

### 3.3 NX\_Programmer (Ver.A) + NX1\_Converter\_Board (Ver.A) 硬體支援對應表

下表為 OTP IC 對應的轉接板及轉卡來支援不同系列的 Nyquest IC。

Series	P/N	Type	轉卡 (Config Card)	轉接板 (Transfer Board)	通用轉接板 (Uni-Transfer Board)
NX1xPxx	NX11PxxAB	COB	9. NX1 Config Card	NX1 COB Transfer Board Ver.A	
	NX12PxxAB	COB			
	NX13PxxAB	COB			
	NX11P21xS16	SOP16	20. NX11P21 SOP16 Config Card	NY8A/8B/3W/9UP SOP16 Transfer Board Ver.A	SOP16 Transfer Board Ver.A
	NX11P21xU24	SSOP24	21. NX11P21 SSOP24 Config Card	NY8A/8B/9UP SSOP24/28(150mil) Transfer Board Ver.A	SSOP24/28(150mil) Transfer Board Ver.A
	NX11P22xU24	SSOP24	13. NX11P22 SSOP24 Config Card	NY8A/8B/9UP SSOP24/28(150mil) Transfer Board Ver.A	SSOP24/28(150mil) Transfer Board Ver.A
	NX12P64xU24	SSOP24	26. NX12P64 SSOP24 Config Card	NY8A/8B/9UP SSOP24/28(150mil) Transfer Board Ver.A	SSOP24/28(150mil) Transfer Board Ver.A
	NX13P64xU24	SSOP24	26. NX12P64 SSOP24 Config Card	NY8A/8B/9UP SSOP24/28(150mil) Transfer Board Ver.A	SSOP24/28(150mil) Transfer Board Ver.A
	NX11P22xQ48	LQFP48	14. NX11P22 LQFP48 Config Card	NX1 LQFP48 Transfer Board Ver.A	LQFP48 Transfer Board Ver.A
	NX12P44xQ32	LQFP32	18. NX12P34/44/54/64 LQFP32 Config Card	NX1 LQFP32 Transfer Board Ver.A	LQFP32 Transfer Board Ver.A
NX12P44xQ64	LQFP64	19. NX12P34/44/54/64 LQFP64 Config Card	NX1 LQFP64 Transfer Board Ver.A	LQFP64 Transfer Board Ver.A	

Series	P/N	Type	轉卡 (Config Card)	轉接板 (Transfer Board)	通用轉接板 (Uni-Transfer Board)
	NX13P44xQ32	LQFP32	18. NX13P34/44/54/64 LQFP32 Config Card	NX1 LQFP32 Transfer Board Ver.A	LQFP32 Transfer Board Ver.A
	NX13P44xQ64	LQFP64	19. NX13P34/44/54/64 LQFP64 Config Card	NX1 LQFP64 Transfer Board Ver.A	LQFP64 Transfer Board Ver.A
	NX12P64xQ48	LQFP48	27. NX12P34/54/64 LQFP48 Config Card	NX1 LQFP48 Transfer Board Ver.A	LQFP48 Transfer Board Ver.A
	NX13P64xQ48	LQFP48	27. NX12P34/54/64 LQFP48 Config Card	NX1 LQFP48 Transfer Board Ver.A	LQFP48 Transfer Board Ver.A
NX11M2x	NX11M2xAS8	SOP8	23. NX11M2x SOP8 Config Card	NY8A/8B/3W/9UP SOP16 Transfer Board Ver.A	SOP16 Transfer Board Ver.A
	NX11M2xAS16	SOP16	24. NX11M2x SOP16 Config Card		
NX12M5x	NX12M5xAS16	SOP16	32. NX12M5x SOP16 Config Card	NY8A/8B/3W/9UP SOP16 Transfer Board Ver.A	SOP16 Transfer Board Ver.A
	NX12M5xU24	SSOP24	33. NX12M5x SSOP24 Config Card	NY8A/8B/9UP SSOP24/28(150mil) Transfer Board Ver.A	SSOP24/28(150mil) Transfer Board Ver.A
NX13M5x	NX13M5xAS16	SOP16	32. NX12M5x SOP16 Config Card	NY8A/8B/3W/9UP SOP16 Transfer Board Ver.A	SOP16 Transfer Board Ver.A
	NX13M5xU24	SSOP24	33. NX12M5x SSOP24 Config Card	NY8A/8B/9UP SSOP24/28(150mil) Transfer Board Ver.A	SSOP24/28(150mil) Transfer Board Ver.A
NX11S2x	NX11S2xAS8	SOP8	23. NX11M2x SOP8 Config Card	NY8A/8B/3W/9UP SOP16 Transfer Board Ver.A	SOP16 Transfer Board Ver.A
	NX11S2xAS16	SOP16	24. NX11M2x SOP16 Config Card		

### 3.4 Smart\_Writer Ver.A 硬體支援對應表

下表為 OTP IC 對應的轉接板及轉卡來支援不同系列的 Nyquest IC。

Series	P/N	Type	轉卡 (Config Card)	轉接板 (Transfer Board)	通用轉接板 (Uni-Transfer Board)
NY1P	NY1P207AB	COB	1. NY1/2/3/4/5/7P Config Card	NY1P/2P/3P COB Transfer Board Ver.A	
	NY1P207AS8	SOP8		NY3P SOP8 Transfer Board Ver.A	
	NY1P207AP8	DIP8		NY3P DIP8 Transfer Board Ver.A	
	NY1P207AS14	SOP14		NY3P SOP14 Transfer Board Ver.A	
	NY1P207AP14	DIP14		NY3P DIP14 Transfer Board Ver.A	
NY2P	NY2P010AB	COB	1. NY1/2/3/4/5/7P Config Card	NY1P/2P/3P COB Transfer Board Ver.A	

Series	P/N	Type	轉卡 (Config Card)	轉接板 (Transfer Board)	通用轉接板 (Uni-Transfer Board)
	NY2P010AS8	SOP8		NY3P SOP8 Transfer Board Ver.A	
	NY2P010AP8	DIP8		NY3P DIP8 Transfer Board Ver.A	
	NY2P010AS14	SOP14		NY3P SOP14 Transfer Board Ver.A	
	NY2P010AP14	DIP14		NY3P DIP14 Transfer Board Ver.A	
NY3P	NY3PxxxxB	COB	1. NY1/2/3/4/5/7P Config Card	NY1P/2P/3P COB Transfer Board Ver.A	
	NY3PxxxxC	COB		NY1P/2P/3P COB Transfer Board Ver.A	
	NY3PxxxxD	COB		NY1P/2P/3P COB Transfer Board Ver.A	
	NY3PxxxDS6	SOT23-6	59. NY3P016/035 SOT23-6 Config Card		SOT23-6 Transfer Board Ver.A
	NY3PxxxxS8	SOP8	1. NY1/2/3/4/5/7P Config Card	NY3P SOP8 Transfer Board Ver.A	
	NY3PxxxxP8	DIP8		NY3P DIP8 Transfer Board Ver.A	
	NY3PxxxxS14	SOP14		NY3P SOP14 Transfer Board Ver.A	
	NY3PxxxxP14	DIP14		NY3P DIP14 Transfer Board Ver.A	
NY3PxxxE	SOP8	62. NY3PxxxE SOP8 Config Card	NY3P SOP8 Transfer Board Ver.A		
NY3M	NY3MxxxxB	COB1	1. NY1/2/3/4/5/7P Config Card	NY1P/2P/3P COB Transfer Board Ver.A	
	NY3MxxxxC	COB2			
	NY3MxxxxE8	ESOP8		NY3M ESOP8 Transfer Board Ver.A	
NY3W	NY3WxxxxS8	SOP8	4. NY3W SOP Config Card	NY8A/8B/3W/9UP SOP16 Transfer Board Ver.A	
NY4P	NY4PxxxxB	COB	1. NY1/2/3/4/5/7P Config Card	NY4P/5P/7P COB Transfer Board Ver.A	
	NY4PxxxxS8	SOP8		NY3P SOP8 Transfer Board Ver.A	
	NY4PxxxxS14	SOP14		NY4P SOP14 Transfer Board Ver.A	
	NY4PxxxxP14	DIP14		NY4P DIP14 Transfer Board Ver.A	
NY5P	NY5PxxxxB	COB	1. NY1/2/3/4/5/7P Config Card	NY4P/5P/7P COB Transfer Board Ver.A	
	NY5PxxxxS24	SOP24		NY5P SOP24 Transfer Board Ver.A	
	NY5P185AS28	SOP28		NY5P SOP28 Transfer Board Ver.A	
	NY5PxxxxS28	SOP28		NY5P345/520 SOP28 Transfer Board Ver.A	
	NY5PxxxAQ64	LQFP64		NY5P LQFP64 Transfer Board Ver.A	

Series	P/N	Type	轉卡 (Config Card)	轉接板 (Transfer Board)	通用轉接板 (Uni-Transfer Board)
	NY5PxxxJS24	SOP24	29. NY5P085J SOP24 Config Card	NY8A/8B SOP18/28 Transfer Board Ver.B	SOP18/28 Transfer Board Ver.A
	NY5PxxxJS28	SOP28	30. NY5P185J SOP28 Config Card	NY8A/8B SOP18/28 Transfer Board Ver.B	SOP18/28 Transfer Board Ver.A
	NY5PxxxJQ48	LQFP48	34. NY5P1K2/720/520J LQFP48 Config Card	NX1 LQFP48 Transfer Board Ver.A	LQFP48 Transfer Board Ver.A
NY5Q	NY5QxxxxB	COB	1. NY1/2/3/4/5/7P Config Card	NY4P/5P/7P COB Transfer Board Ver.A	
	NY5QxxxxS8	SOP8	51. NY5Q172 SOP8 Config Card	NY8A/8B/3W/9UP SOP16 Transfer Board Ver.A	SOP16 Transfer Board Ver.A
	NY5QxxxxS16	SOP16	52. NY5Q172 SOP16 Config Card	NY8A/8B/3W/9UP SOP16 Transfer Board Ver.A	SOP16 Transfer Board Ver.A
	NY5QxxxxS14	SOP14	43. NY5Q060/092/172 SSOP24 Config Card NY5Q020/040 SOP14 Config Card	NY8A/8B/3W/9UP SOP16 Transfer Board Ver.A	SOP16 Transfer Board Ver.A
	NY5QxxxxU14	SSOP24		NY8A/8B/9UP SSOP24/28(150mil) Transfer Board Ver.A	SSOP24/28(150mil) Transfer Board Ver.A
	NY5Q342xS28	SOP28	44. NY5Q342 SOP28 Config Card	NY8A/8B SOP18/28 Transfer Board Ver.B	SOP18/28 Transfer Board Ver.A
NY6P	NY6PxxxxB	COB	1. NY1/2/3/4/5/7P Config Card	NY4P/5P/7P COB Transfer Board Ver.A	
	NY6PxxxJS24	SOP24	28. NY6P085J SOP24 Config Card	NY8A/8B SOP18/28 Transfer Board Ver.B	SOP18/28 Transfer Board Ver.A
	NY6PxxxJS28	SOP28	35. NY6P345/185J SOP28 Config Card		
	NY6P025AS14	SOP14	38. NY6P025A SOP14 Config Card	NY8A/8B/3W/9UP SOP16 Transfer Board Ver.A	SOP16 Transfer Board Ver.A
NY7P	NY7PxxxxB	COB	1. NY1/2/3/4/5/7P Config Card	NY4P/5P/7P COB Transfer Board Ver.A	
	NY7PxxxxS28	SOP28		NY7P021/65 SOP28 Transfer Board Ver.A NY7P087/170 SOP28 Transfer Board Ver.A	
	NY7PxxxxQ64	LQFP64		NY7P LQFP64 Transfer Board Ver.A	
NY9UP01x	NY9UP01A1	SOP16	7. NY9UP01A1 SOP16 Config Card	NY8A/8B/3W/9UP SOP16 Transfer Board Ver.A	SOP16 Transfer Board Ver.A
	NY9UP01A2	SOP16	8. NY9UP01A2 SOP16 Config Card		
NY9UP02x	NY9UP02xS16	SOP16	8. NY9UP01A2 SOP16 Config Card	NY8A/8B/3W/9UP SOP16 Transfer Board Ver.A	SOP16 Transfer Board Ver.A
NY9UP64x	NY9UP64xS16	SOP16	6. NY9UP SOP16 Config Card	NY8A/8B/3W/9UP SOP16 Transfer Board Ver.A	SOP16 Transfer Board Ver.A
	NY9UP64xU24	SSOP24	5. NY9UP SSOP24(150mil) Config Card	NY8A/8B/9UP SSOP 24/28(150mil) Transfer Board Ver.A	SSOP 24/28(150mil) Transfer Board Ver.A

Series	P/N	Type	轉卡 (Config Card)	轉接板 (Transfer Board)	通用轉接板 (Uni-Transfer Board)
<b>NY9UP08x</b>	NY9UP08xS16	SOP16	30. NY9UP08 SOP16 Config Card	NY8A/8B/3W/9UP SOP16 Transfer Board Ver.A	SOP16 Transfer Board Ver.A
<b>NY9TP16x</b>	NY9TP16AB	COB	1. NY1/2/3/4/5/7P Config Card	NY4P/5P/7P COB Transfer Board Ver.A	
	NY9TP16xS8	SOP8	16. NY9TP16 SOP8 Config Card	NY3P SOP8 Transfer Board Ver.A (將 SOP Socket Pin-1 與 Pin-4 短路)	
	NY9TP16xS16	SOP16	17. NY9TP16 SOP16 / SOP28 / SSOP24 Config Card	NY8A/8B/3W/9UP SOP16 Transfer Board Ver.A	SOP16 Transfer Board Ver.A
	NY9TP16xU24	SSOP24		NY8A/8B/9UP SSOP24/28(150mil) Transfer Board Ver.A	SSOP24/28(150mil) Transfer Board Ver.A
	NY9TP16xS28	SOP28		NY8A/8B SOP18/28 Transfer Board Ver.B	SOP18/28 Transfer Board Ver.A
<b>NY9TS02x</b>	NY9TS02xS8	SOP8	22. NY9TS02 SOP8 Config Card	NY8A/8B/3W/9UP SOP16 Transfer Board Ver.A	SOP16 Transfer Board Ver.A
<b>NX1xPxx</b>	NX11PxxAB	COB	9. NX1 Config Card	NX1 COB Transfer Board Ver.A	
	NX12PxxAB	COB			
	NX13PxxAB	COB			
	NX11P21xS16	SOP16	20. NX11P21 SOP16 Config Card	NY8A/8B/3W/9UP SOP16 Transfer Board Ver.A	SOP16 Transfer Board Ver.A
	NX11P21xU24	SSOP24	21. NX11P21 SSOP24 Config Card	NY8A/8B/9UP SSOP24/28(150mil) Transfer Board Ver.A	SSOP24/28(150mil) Transfer Board Ver.A
	NX11P22xU24	SSOP24	13. NX11P22 SSOP24 Config Card	NY8A/8B/9UP SSOP24/28(150mil) Transfer Board Ver.A	SSOP24/28(150mil) Transfer Board Ver.A
	NX12P64xU24	SSOP24	26. NX12P34/54/64 SSOP24 Config Card	NY8A/8B/9UP SSOP24/28(150mil) Transfer Board Ver.A	SSOP24/28(150mil) Transfer Board Ver.A
	NX13P64xU24	SSOP24	26. NX12P34/54/64 SSOP24 Config Card	NY8A/8B/9UP SSOP24/28(150mil) Transfer Board Ver.A	SSOP24/28(150mil) Transfer Board Ver.A
	NX11P22xQ48	LQFP48	14. NX11P22 LQFP48 Config Card	NX1 LQFP48 Transfer Board Ver.A	LQFP48 Transfer Board Ver.A
	NX12P44xQ32	LQFP32	18. NX12P34/44/54/64 LQFP32 Config Card	NX1 LQFP32 Transfer Board Ver.A	LQFP32 Transfer Board Ver.A
	NX12P44xQ64	LQFP64	19. NX12P34/44/54/64 LQFP64 Config Card	NX1 LQFP64 Transfer Board Ver.A	LQFP64 Transfer Board Ver.A
	NX13P44xQ32	LQFP32	18. NX12P34/44/54/64 LQFP32 Config Card	NX1 LQFP32 Transfer Board Ver.A	LQFP32 Transfer Board Ver.A
	NX13P44xQ64	LQFP64	19. NX12P34/44/54/64 LQFP64 Config Card	NX1 LQFP64 Transfer Board Ver.A	LQFP64 Transfer Board Ver.A

Series	P/N	Type	轉卡 (Config Card)	轉接板 (Transfer Board)	通用轉接板 (Uni-Transfer Board)
	NX12P64xQ48	LQFP48	27. NX12P34/54/64 LQFP48 Config Card	NX1 LQFP48 Transfer Board Ver.A	LQFP48 Transfer Board Ver.A
	NX13P64xQ48	LQFP48	27. NX12P34/54/64 LQFP48 Config Card	NX1 LQFP48 Transfer Board Ver.A	LQFP48 Transfer Board Ver.A
NX11M2x	NX11M2xAS8	SOP8	23. NX11M2x SOP8 Config Card	NY8A/8B/3W/9UP SOP16 Transfer Board Ver.A	SOP16 Transfer Board Ver.A
	NX11M2xAS16	SOP16	24. NX11M2x SOP16 Config Card		
NX12M5x	NX12M5xAS16	SOP16	32. NX12M5x SOP16 Config Card	NY8A/8B/3W/9UP SOP16 Transfer Board Ver.A	SOP16 Transfer Board Ver.A
	NX12M5xU24	SSOP24	33. NX12M5x SSOP24 Config Card	NY8A/8B/9UP SSOP24/28(150mil) Transfer Board Ver.A	SSOP24/28(150mil) Transfer Board Ver.A
NX13M5x	NX13M5xAS16	SOP16	32. NX12M5x SOP16 Config Card	NY8A/8B/3W/9UP SOP16 Transfer Board Ver.A	SOP16 Transfer Board Ver.A
	NX13M5xU24	SSOP24	33. NX12M5x SSOP24 Config Card	NY8A/8B/9UP SSOP24/28(150mil) Transfer Board Ver.A	SSOP24/28(150mil) Transfer Board Ver.A
NX11S2x	NX11S2xAS8	SOP8	23. NX11M2x SOP8 Config Card	NY8A/8B/3W/9UP SOP16 Transfer Board Ver.A	SOP16 Transfer Board Ver.A
	NX11S2xAS16	SOP16	24. NX11M2x SOP16 Config Card		
NX1xFSxx	NX1xFxxAB	COB	9. NX1 Config Card	NX1 COB Transfer Board Ver.A	
	NX1xFSx1AS16	SOP16	46. NX12FM5x/NX12FS51 SOP16 Config Card	NY8A/8B/3W/9UP SOP16 Transfer Board Ver.A	SOP16 Transfer Board Ver.A
	NX1xFSx1AQ32	LQFP32	48. NX12FS51 LQFP32 Config Card	NX1 LQFP32 Transfer Board Ver.A	LQFP32 Transfer Board Ver.A
	NX1xFSx1AU28	SSOP28	47. NX12FS51 SSOP28 Config Card	NY8A/8B/9UP SSOP24/28(150mil) Transfer Board Ver.A	SSOP24/28(150mil) Transfer Board Ver.A
	NX1xFSx1AU24	SSOP24	50. NX12FS51 SSOP24 Config Card	NY8A/8B/9UP SSOP24/28(150mil) Transfer Board Ver.A	SSOP24/28(150mil) Transfer Board Ver.A
NX11FS2x	NX11FS2xAS8	SOP8	54. NX11FS2x SOP8 Config Card	NY8A/8B/3W/9UP SOP16 Transfer Board Ver.A	SOP16 Transfer Board Ver.A
	NX11FS2xAS16	SOP16	55. NX11FS2x SOP16 Config Card	NY8A/8B/3W/9UP SOP16 Transfer Board Ver.A	SOP16 Transfer Board Ver.A
	NX11FS2xAU24	SSOP24	56. NX11FS2x SSOP24 Config Card	NY8A/8B/9UP SSOP24/28(150mil) Transfer Board Ver.A	SSOP24/28(150mil) Transfer Board Ver.A
NX1xFMxx	NX1xFMxxAS16	SOP16	46. NX12FM5x/NX12FS51 SOP16 Config Card	NY8A/8B/3W/9UP SOP16 Transfer Board Ver.A	SOP16 Transfer Board Ver.A
	NX12FMxxAU28	SSOP28	49. NX12FM5x SSOP28 Config Card	NY8A/8B/9UP SSOP24/28(150mil) Transfer Board Ver.A	SSOP24/28(150mil) Transfer Board Ver.A
N25Qxxx	N25QxxxAS8	SOP8	53. SPI_Flash SOP8 Config Card	NY8A/8B/3W/9UP SOP16 Transfer Board Ver.A	SOP16 Transfer Board Ver.A

## 4. 改版記錄

### 改版記錄

版本	日期	內容描述	修正頁
-	-	從 Hardware Tool 使用手冊截取 6.8 章節內容建立 Hardware Tool Appendix 檔。	-
3.6	2020/09/04	<ol style="list-style-type: none"> <li>1. 新增 NY6P025A SOP14 Config Card。</li> <li>2. 更新 NY6P025A SOP14 Config Card 與 Transfer Board 對應表。</li> </ol>	<p>15</p> <p>17, 24</p>
3.7	2020/11/30	<ol style="list-style-type: none"> <li>1. 新增 NY8B061x SOP8/SOP14/SOP16 Config Card。</li> <li>2. 新增 NY8B062x SOP14 Config Card。</li> <li>3. 新增 NY9UP02A SOP16 Config Card。</li> <li>4. 新增 NY8TM52D SOP/DFN8 Config Card。</li> </ol>	12-21
3.71	2021/01/29	<ol style="list-style-type: none"> <li>1. 新增 NY8BE62x SOP8 Config Card。</li> <li>2. 新增 NY8BE62x SOP16 Config Card。</li> <li>3. 更新 NY8-OTP_Writer Config Card 與 Transfer Board 對應表</li> </ol>	<p>15</p> <p>16</p> <p>21</p>
3.80	2021/05/28	<ol style="list-style-type: none"> <li>1. 新增支持 NY8BE62x SOP14、NY8B060x SOP8、NY8TM52x SOT23-6、NY8BM52x DIP-20 對應表。</li> <li>2. 修正相關文字錯誤。</li> </ol>	<p>21</p> <p>-</p>
3.90	2021/09/30	<ol style="list-style-type: none"> <li>1. NY5Q020/040 SOP14、NY5Q060/092/172 SSOP24 Config Card、NY5Q342 SOP28 Config Card、NX13FS51 SOP16 Config Card、NX13FS51 SSOP24 Config Card。</li> <li>2. 新增支持對應表。</li> <li>3. 修正相關文字錯誤。</li> </ol>	<p>12</p> <p>24</p> <p>-</p>
3.91	2021/11/30	<ol style="list-style-type: none"> <li>1. 新增 NY8TE64 SOP20、NY8TE64 SOP16、NX12FM5x/NX12FS51 SOP16、NX12FS51 SSOP28、NX12FS51 LQFP32、NX12FM5x SSOP28 Config Card。</li> <li>2. 更新支持對應表。</li> <li>3. 修正相關文字錯誤</li> </ol>	<p>16</p> <p>21, 24</p> <p>-</p>

版本	日期	內容描述	修正頁
4.00	2022/02/25	<ol style="list-style-type: none"> <li>新增 NX12FS51 SSOP24、NY5Q172 SOP8、NY5Q172 SOP16 轉卡。</li> <li>更新轉接板與轉卡對應表。</li> <li>修正錯字。</li> </ol>	<p>16</p> <p>22, 24, 25</p> <p>-</p>
4.10	2022/05/31	NX1 轉換板與 NX11M_SPI_Handler 轉換板提示限 NX1xPxx、NX11M2x、NX11M5x 使用。	10
4.20	2022/08/31	新增 MCU_Writer (Ver.A)支援轉卡與轉板。	22
4.30	2022/11/30	新增 SPI_Flash SOP8 轉卡。	17
4.31	2023/02/24	<ol style="list-style-type: none"> <li>新增 NX11FS2x SOP8 轉卡、NX11FS2x SOP16 轉卡、NX11FS2x SSOP24 轉卡圖片。</li> <li>新增 NY8BE64x 硬體支援對應表。</li> <li>新增 NY4PxxxxS8 硬體支援對應表。</li> <li>新增 NX11FS2x 硬體支援對應表。</li> </ol>	<p>17</p> <p>22</p> <p>24</p> <p>25</p>
4.40	2023/05/31	<ol style="list-style-type: none"> <li>移除 SPI 轉接板相關說明。</li> <li>更新 NX11FS2x SOP8、NX11FS2x SOP16 和 NX11FS2x SSOP24 轉卡圖片。</li> </ol>	<p>-</p> <p>16</p>
4.50	2023/08/31	新增 NY8B062 SOP8 轉卡、NY8B062 SOP14 轉卡。	20
4.60	2024/05/31	新增轉卡 NY3P016/35 SOT23-6 轉卡、NY8BM61 QFN16 轉卡、NY8BM62 SOP18 轉卡。	16
4.70	2024/08/26	<ol style="list-style-type: none"> <li>新增 SOT23-6 轉接板說明。</li> <li>新增 1.10 QFN16 轉接板。</li> <li>新增 NY8BE62 SOP14 / SOP16 轉卡。</li> <li>新增 NY8BM61 QFN16 轉卡、NY8BM62 QFN16 轉卡。</li> </ol>	<p>6</p> <p>9</p> <p>24</p> <p>25</p>
4.90	2025/05/23	<ol style="list-style-type: none"> <li>移除 OTP_Writer Ver.C 相關說明。</li> <li>新增 NY8BM62 SOP8 轉卡、NY3PxxxE SOP8 轉卡、NY8BM84/8F2481 TSSOP20 轉卡、NY8BM84/8F2481 SSOP24/QFN24 轉卡、NY8BM84/8F2481 SOP16 轉卡。</li> </ol>	<p>--</p> <p>18, 19, 21, 25</p>